

# INSTALLATION INSTRUCTIONS

**CAUTION:** For your safety and proper operation of this fixture, read instructions carefully before you start. Note and understand all safety information in **bold print**.

## WRAP AROUND LIGHT FIXTURE

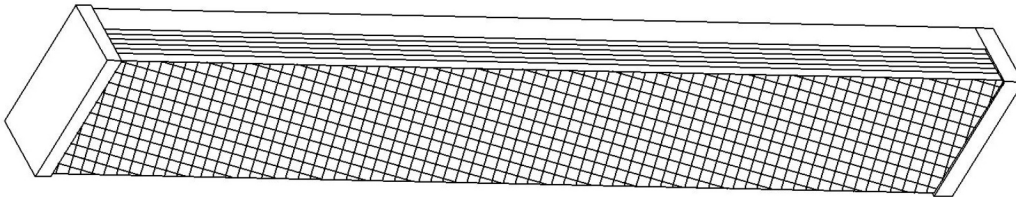

### **IMPORTANT SAFETY INFORMATION FOR YOUR PROTECTION, READ CAREFULLY**

**1) WARNING: RISK OF SHOCK**

House electric current can cause painful shock or serious injury unless handled properly.

For your safety, always remember to:

- Turn off the power supply at the fuse or circuit breaker box before you install the fixture.
- Turn off the power supply again when you change lamps or perform other maintenance.
- Ground the fixture to avoid potential electric shocks and to ensure reliable starting.
- Double check all connections to be sure they are all tight and correct.
- Wear rubber-soled shoes and work on a sturdy wooden ladder.

Couper le courant au niveau du disjoncteur avant d'installer la lampe pour éviter tout risque de secousse électrique.

- 2) This fixture is designed for use in a circuit protected by a fuse or circuit breaker. It is also designed to be installed in accordance with local electrical codes. If you are unsure about the wiring, consult a qualified electrician and check your local electrical code.

Tous les branchements électrique doivent respecter les normes du Code National de l'Électricité. Si vous ne savez pas comment installer correctement des fils électriques, appelez un électricien professionnel.

**3) WARNING: RISK OF CUTS**

Some metal parts in the fixture may have sharp edges. To prevent possible cuts and scrapes, we suggest gloves to be worn when handling all parts from this fixture.

- 4) Account for small parts and destroy packing material, as these may be hazardous to children.

**5) WARNING: RISK OF FIRE**

Most dwellings built before 1985 have supply wire rated 60°C.

wire must be suitable for at least 90 °C ( 194 °F ). Consult a qualified electrician before installing.

LES FILS D'ALIMENTATION 90°C MIN.

A) LAMP HOUSING	1 UNIT	C) WIREWAY COVER	1 UNIT	A) PLIERS	C) PHILPS SCREWDRIVER
B) LENS	1 UNIT	D) WOOD SCREWS	4 UNITS	B) HAMMER	D) SAFETY GLASSES
		E) WIRENUTS	3 UNITS		

# INSTALLATION INSTRUCTIONS

**WARNING:** Before wiring to the power supply, turn off the electricity at fuse or circuit breaker box. Ensure grounding to avoid potential electrical shock and to ensure reliable lamp starting.

## PREPARATION OF LIGHT FIXTURE FOR INSTALLATION

- 1) Remove the Acrylic lens from the fixture and place aside on a flat surface to avoid damage to the lens. To remove the lens, carefully slide the lens to one end of the fixture. Gently grab the lens and pull it out.

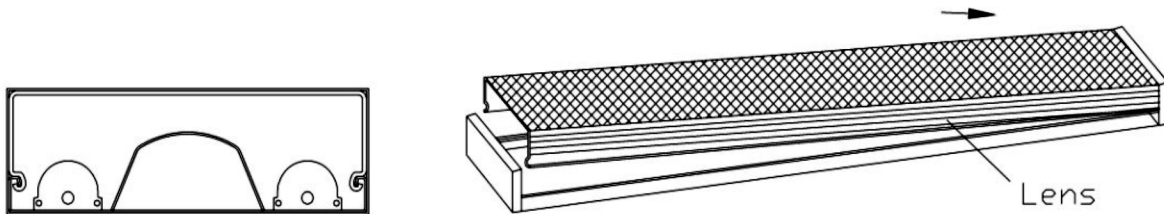

- 2) Squeeze wireway cover at both ends on both sides to release from the fixture housing. Remove the cover and place aside on a flat surface for later use.

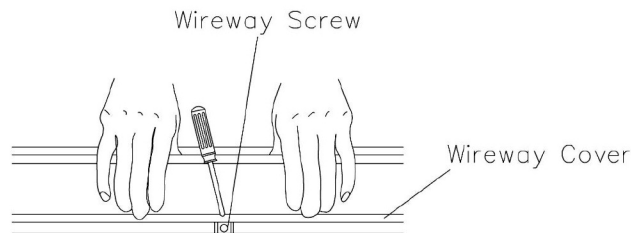

- 3) Carefully turn the fixture housing over and locate the center knockout on the housing. Make sure the fixture housing is supported on the underside and then by placing a screwdriver on the edge of the knockout ( opposite retaining tabs ), strike the screwdriver end by the use of a hammer ( **SAFETY GLOVES AND GLASSES SHOULD BE WORN WHEN REMOVING ANY KNOCKOUTS** ). Grasp the knockout with the use of pliers and flex in a back and forth motion until the tab breaks off.

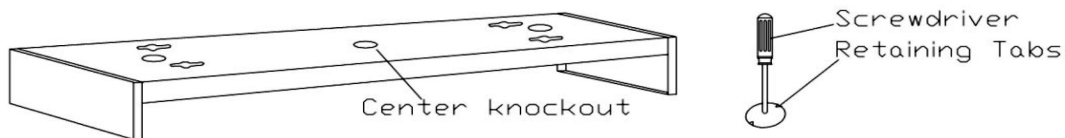

- 4) Coordinate mounting position in the room. Supply wires of house wires will extend from the " **JUNCTION BOX** " located in the ceiling. If you not have a " **JUNCTION BOX** " in the ceiling, consult a qualified professional electrician.

## CAUTION

Check both the fixture and house for loose or damaged wiring. If the wiring is loose or damaged, it must be repaired prior to the fixture installation. **DO NOT PROCEED ON UNTIL THE WIRING HAS BEEN FIXED OR REPLACED WITH NEW WIRES.**

# INSTALLATION INSTRUCTIONS

**NOTE:** This fixture is designed to be surfaced mounted on a drywall ceiling. Mounting hardware requirements will depend on mounting method.

## MOUNTING OF THE LIGHT FIXTURE

A) For mounting on drywall ceilings:

- 1) Lift fixture housing to the ceiling, positioning the center knockout of the housing over the junction box and parallel to the ceiling. See Diagram 1.
- 2) Mark ceiling with a pencil for the drill hole locations through the narrow portion on the 4 keyhole slots. See Diagram 2, 3.

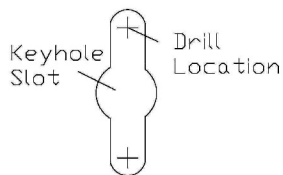

Diagram 2

- 3) Drill 1/8" pilot hole at each location.
- 4) If drill encounters ceiling joist, use wood screws ( provided ) & washers ( not included ) to secure fixture housing to the ceiling. See diagram 4.
- 5) If drill **DOES NOT ENCOUNTER CEILING JOIST**, use 4 toggle bolts and washers ( both not included ). Enlarge the pilot drill hole size large enough to accommodate the toggle bolts tighten and secure fixture housing to ceiling. See Diagram 5.

### SAFETY TIP

- 6) Reinforce the mounting of the housing to the ceiling by adding a board between the expansion part of the toggle bolt and the ceiling tile. See Diagram 6.

Diagram 1

Junction Box (Not Included)

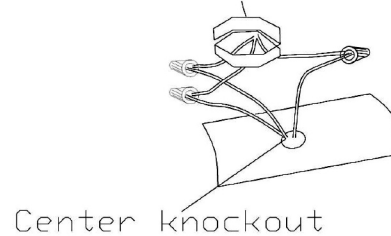

Diagram 3

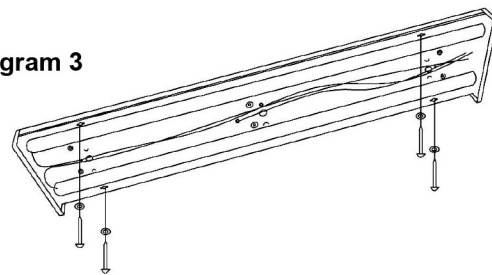

Diagram 4

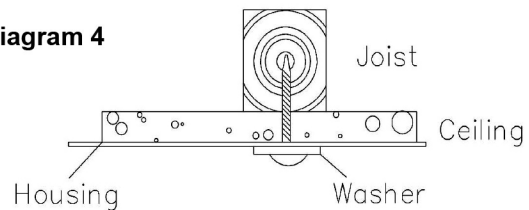

Diagram 5

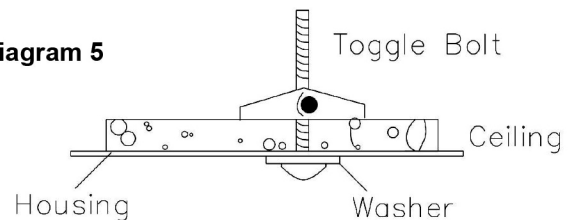
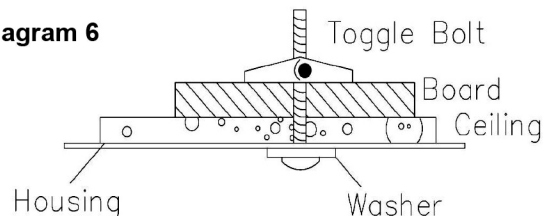

Diagram 6



# INSTALLATION INSTRUCTIONS

**WARNING:** Before wiring to the power supply, turn off the electricity at fuse or circuit breaker box. Ensure grounding to avoid potential electrical shock and to ensure reliable lamp starting.

## WIRING OF THE LIGHT FIXTURE

- 1) Connect the black supply ( house ) wire to the black wire from the light fixture. Secure the connection by inserting into the wirenut, then revolving until secure. Diagram 1.
- 2) Connect the white supply ( house ) wire to the white wire from the light fixture. Secure the connection by inserting into the wirenut, then revolving until secure. Diagram 1.

**CHECK TO MAKE SURE NO BARE WIRES ARE EXPOSED OUTSIDE THE WIRENUTS.**

- 3) To ground the fixture, connect the bare or green supply ( house ) wire to the green wire comes with the fixture by inserting into the wirenut, then revolving until secure. Diagram 1.

**IF THE HOUSE WIRING DOES NOT HAVE A GROUND WIRE, CONSULT YOUR LOCAL ELECTRIC CODE FOR APPROVED METHOD.**

Attacher le cable d'alimentation noir au cable noir de la lampe ,et le Cable d'alimentation blanc au cable blanc de la lampe à l'aide des connecteurs, Raccorder le fil de terre de la lampe au fil de terre de l'alimentation en utilisant un connecteur.

- 4) Replace the wireway cover by reversing the steps as described on page 2, point 2. See Diagram 2.

**THE FIXTURE SHOULD NOT BE OPERATED WITHOUT THE WIREWAY COVER IN PLACE.**

- 5) Replace the lens by reversing the steps as described on page 2, point #1. See Diagram 3.

**BE EXTREMELY CAREFUL WHEN REPLACING THE LENS BACK ON THE LIGHT FIXTURE TO AVOID POSSIBLE DAMAGE TO THE LENS.**

Diagram 1

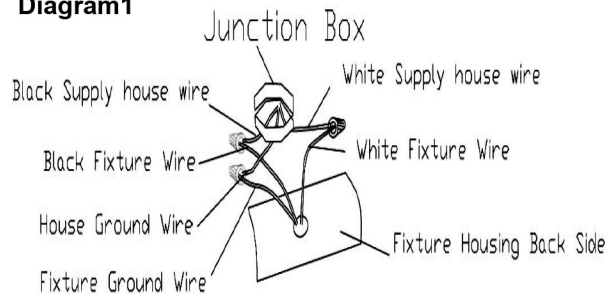

Diagram 2

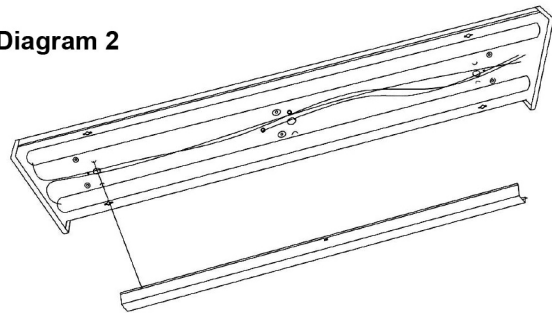

Diagram 3

